

owner's manual

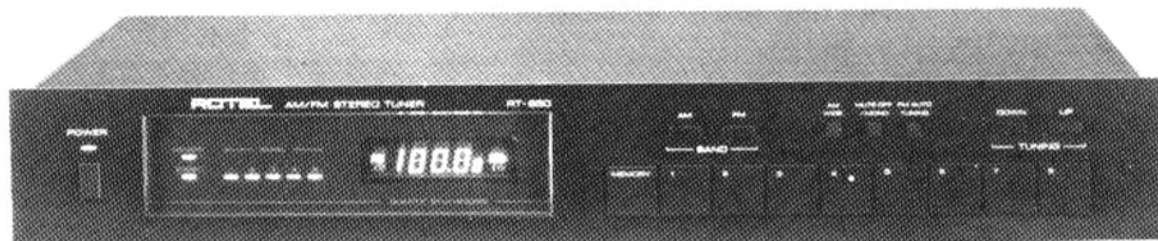

PHOTO: RT-850

Quality. Uncompromised.

ROTEL[®]

RT-850

AM/FM STEREO TUNER

RT-850L

MW/LW/FM STEREO TUNER

ENGLISH	1
DEUTSCH	4
FRANÇAIS	7

WARNING

TO PREVENT FIRE OR SHOCK HAZARD,
DO NOT EXPOSE THIS APPLIANCE TO
RAIN OR MOISTURE

Write your SERIAL NUMBER here.

The number is located near the name
plate on the rear panel.



ENGLISH

AM/FM STEREO SYNTHESIZER TUNER RT-850
MW/LW/FM STEREO SYNTHESIZER TUNER RT-850L

CAUTION

As long as the power cord is plugged into an AC outlet, power is supplied to the unit regardless of the setting of the Power Button.

INTRODUCTION

We at Rotel want to thank you for purchasing our audio product.

Rotel audio products are designed to use the latest electronic technology, and they incorporate our long experience as a specialist manufacturer of audio equipment. We are confident that you will find satisfaction in the high quality sound and top performance, and that you will find pleasure in the functional beauty achieved through human-engineering concept. Before starting operation, please read this instruction manual thoroughly and acquaint yourself with the proper mode of using the unit and all its connections.

We hope you will enjoy top-notch performance for many years to come.

INSTALLATION

Be sure to place the unit in a level and flat place where it is free from humidity, vibration, high temperature and not exposed to direct sunlight. Be careful not to place the unit in a highly enclosed place such as near a wall or on a bookshelf. A poor ventilation will cause undesirable effects to the unit.

POWER SUPPLY CONNECTION

For power the unit requires the normal house electrical current (AC). You may simply plug the unit into a wall outlet, or into your amplifier's unswitched AC outlet.

Note that when you plug the power cord into a switched outlet on amplifier, the stored memory will be lost three days after switching off the amplifier.

CAUTION: Do not apply power without first making sure the proper connections are completed. If you live in U.K. and your unit comes with 2-core cord without a plug, be sure to read the exclusive caution for U.K.

EXCLUSIVE NOTE FOR U.K.

If your unit comes with a 2-core cable without a plug, make certain live and neutral leads are connected to the proper terminals. Check that the terminals are screwed down firmly and no loose strands of wire are present.

IMPORTANT: The wires in this mains lead are coloured in accordance with the following code:

BLUE: NEUTRAL
BROWN: LIVE

As the colours of the wires in the mains lead of this apparatus may not correspond with the coloured markings identifying the terminals in your plug proceed as follows. The wire which is coloured BLUE must be connected to the terminal which is marked with the letter N or coloured BLUE or BLACK. The wire which is coloured BROWN must be connected to the terminal which is marked with the letter L or coloured BROWN or RED.

CONNECTION TO INTEGRATED AMPLIFIER

Using RCA pin cords, securely connect the OUTPUT terminals on the rear panel of the unit to the TUNER (or AUX) terminals of amplifier. Make absolutely sure that RIGHT terminal of one unit is connected to the RIGHT terminal of the other, and LEFT to LEFT.

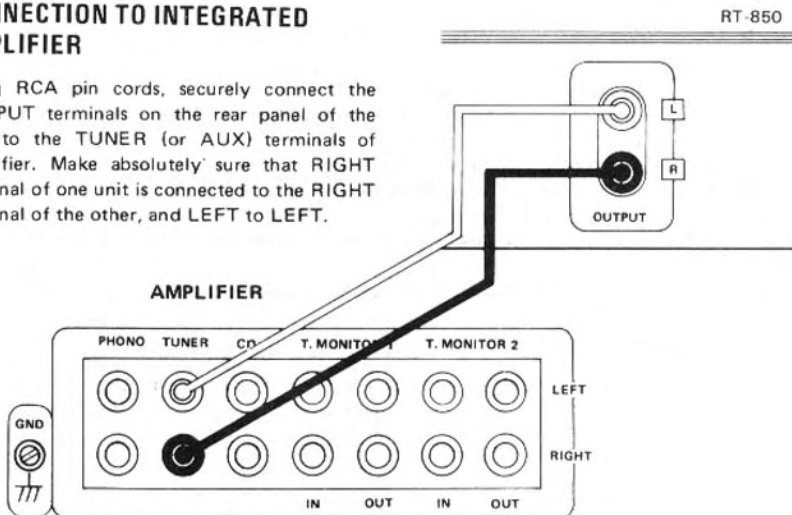

ANTENNA INSTALLATION AND CONNECTION

FM Antenna

For optimum FM reception, connect your 75-ohm coaxial antenna cable to the coaxial socket provided. For some countries, a 75-ohm → 300-ohm conversion adapter is available for connection with 300-ohm antenna (external type or indoor T-shape wire type).

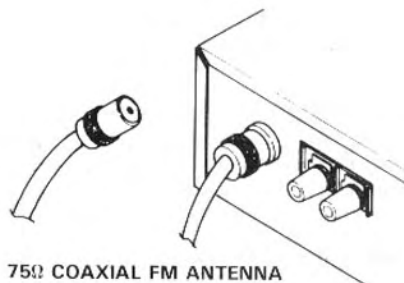

75Ω COAXIAL FM ANTENNA

AM Antenna

The loop antenna is provided for optimum AM reception. Attach the loop antenna onto the antenna holder on the rear panel, and connect the lead wires to the antenna screw terminals marked "G" and "AM". If an outdoor antenna is desired for better reception due to difficult reception area, connect such antenna to the same screw terminals as the loop antenna. Please note that the loop antenna should be left connected to the terminals even when the external antenna connected.

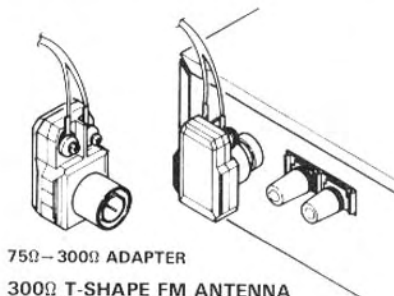

75Ω-300Ω ADAPTER

300Ω T-SHAPE FM ANTENNA

OUT DOOR AM ANTENNA

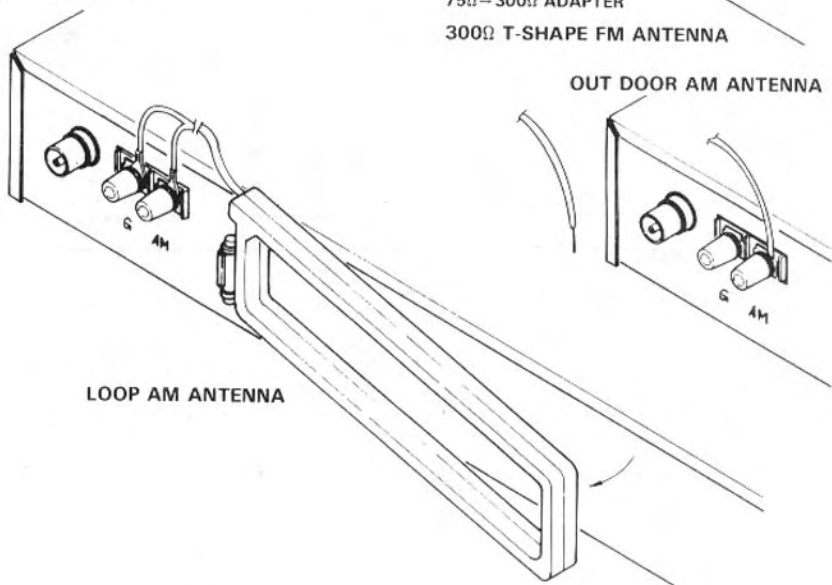

LOOP AM ANTENNA

EXCLUSIVE NOTES FOR THE U.S.A.

Outdoor Antenna Grounding

If an outside antenna is connected to the receiver/tuner, be sure the antenna system is grounded so as to provide some protection against voltage surges and built up static charges. Section 810 of the National Electrical Code, ANSI/NFPA No. 70-1978, provides information with respect to proper grounding of the mast and supporting structure, grounding of the lead-in wire to an antenna discharge unit, size of grounding conductors, location of antenna-discharge unit, connection to grounding electrodes, and requirements for the grounding electrode. See figure.

- Use No. 10 AWG copper or No. 8 AWG aluminum or No. 17 AWG copper-clad steel or bronze wire, or larger as ground wires for both mast and lead-in.
- Secure lead-in wire from antenna to antenna discharge unit and mast ground wire to house with stand-off insulators, spaced from 4 feet (1.22 meters) to 6 feet (1.83 meters) apart.
- Mount antenna discharge unit as closely as possible to where lead-in enters house.

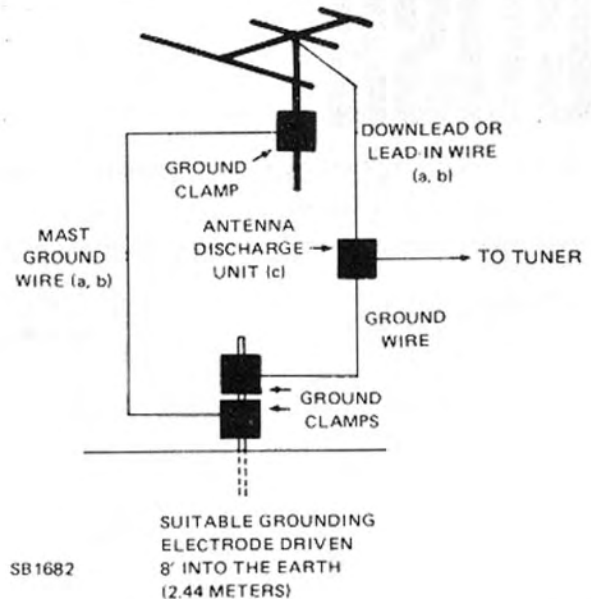

SWITCHES AND CONTROLS

(1) Power Button

This button turns on the unit. The LED indicator above it will glow when the power is on. Press the button a second time to turn off the power.

(2) Memory Indicator

This LED indicator lights up when Memory button is pushed on. It will remain lit for a few seconds to show that the memory circuit is activated.

(3) Stereo Indicator

Glowes when stereo broadcasting signal is tuned in. Note that when stereo signal is very weak, the unit will not give stereo reproduction, and the indicator will not light up.

(4) Signal Strength Indicator

The 5 LEDs show incoming signal strength; the receiving condition is optimal when all 5 LEDs are illuminated.

(5) Frequency Display

In the station frequency displaying "FM" and "MHz" appear in FM reception, and "AM" and "KHz" in AM reception.

(6) Memory Button

To enter a given station frequency into the unit's memory circuit, press this button first, and then tap the desired station button.

(7) Station Buttons

These buttons are used to tune in to desired preset stations, or to preset given station frequencies in unit's memory.

(8) Tuning Button, UP

Used when tuning in a station whose frequency is higher than the reading on the frequency display.

(9) Tuning Button, DOWN

Used when tuning in a station whose frequency is lower than the reading on the frequency display.

(10) FM Auto Tuning Button

Depressing this button changes FM tuning mode from manual to automatic. This button has no effect on AM tuning, which can be done in manual mode only.

(11) FM Mute Off/Mono Button

When this button is pressed to ON, any FM broadcast is received monaurally. Be sure to leave the button in the released (OFF) position during normal stereo FM reception. In the OFF position, interstation noise generated when tuning in an FM station will be reduced.

(12) AM Bandwidth Button

Push this button on to WIDE for a wider bandwidth to enjoy better AM sound. If there is too much hiss or noise from neighbouring stations, etc., push the button to the off position for a normal bandwidth to cut off such noise as much as possible.

(13) AM/FM Selector

Press AM button for AM signal reception, and FM button for FM signal reception. RT-850L gives AM reception in either MW or LW mode. Depress MW button for middle wave reception, and LW button for long wave reception.

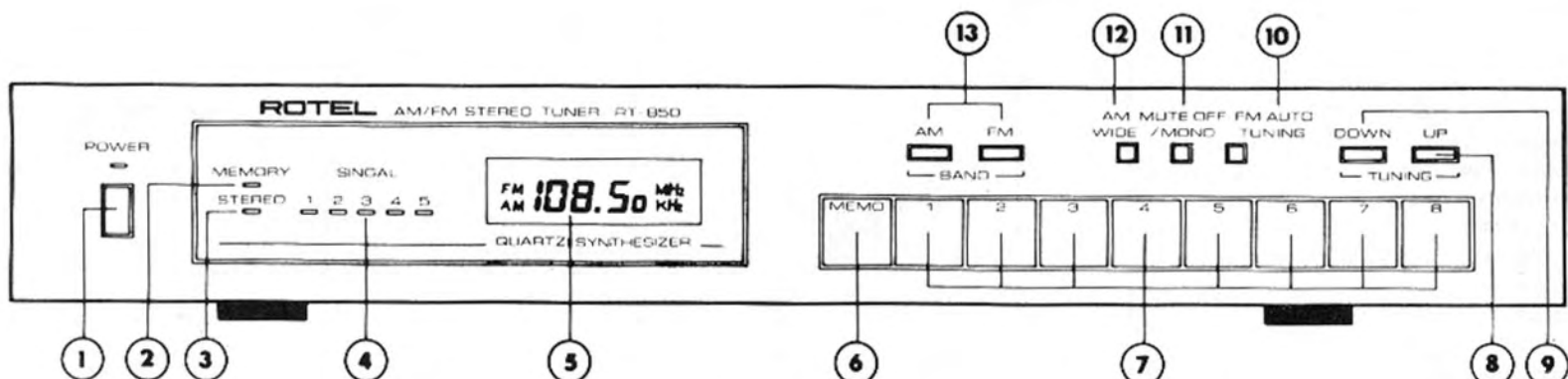

OPERATION

• The RT-850 (RT-850L) employs a quartz PLL synthesizer for easy and accurate tuning. Tuning frequency is visible on the digital read-out, and you can tune in to the desired station accurately. With the unit's memory circuit, you can preset memory tuning. This is a feature only a synthesized tuner can offer, letting you recall a stored station frequency instantly with a single tap of a button.

• One station button can store one AM and one FM station in its memory. With the 8 station buttons, a total of 8 AM and 8 FM stations can be stored.

The RT-850L memory stores a total of 8 FM stations, and 8 MW/LW stations.

• The power source of the unit's memory circuit is the capacitor back-up type. If power cord is unplugged, or if there is a power failure, the electrical energy accumulated in the capacitor while the unit was ON will retain the frequencies stored in the memory circuit for three days. (The memory is retained as long as the power cord is plugged into an AC outlet, regardless of the position of the POWER button.) If you leave the power cord unplugged for over three days, the stored frequencies will be lost.

• Before commencing operation, check to make sure all antenna, amplifier and power connections are properly made.

1. Set the volume control on the amplifier to minimum position, and amplifier function switch to TUNER position (or to AUX position if the tuner is connected to AUX terminal).

2. Turn on the amplifier and press the POWER button on the tuner.

3. Depress FM or AM button of the tuner function selector.

On RT-850L, select among FM, MW, and LW buttons.

4. Tune in to the desired station by means of tuning or station buttons. (See section on "Tuning".)

5. Raise the volume to the desired level, and enjoy listening.

Tuning

The unit is designed to permit three modes of tuning: auto tuning, manual tuning, and preset memory tuning.

• Auto Tuning (for FM Reception Only)

Set FM Auto Tuning button to the depressed position. Press Tuning button, UP or DOWN. Automatic scanning of FM band begins. Scanning stops when it reaches a point where the input signal exceeds a certain acceptable level. To tune in to another station, press DOWN or UP button according to the frequency of the desired station.

• Manual Tuning

Set FM Auto Tuning button to the released position. A tap of the tuning button, DOWN or UP, will shift the tuning frequency in specified increments. If you keep the button pressed down, the frequency will change continuously. Release the button to stop frequency change.

• Preset Memory Tuning

Tune in to the desired station in either auto or manual tuning mode. Press the Memory Program button. Then, press any station button, 1 through 8, to enter the frequency into the memory circuit. Thereafter, you may recall the same frequency any time simply by pressing the same button.

Note: that once the Memory Program button is pressed, you must press the appropriate station button within several seconds to enter the station frequency. If more time elapses before

you press the station button, entry cannot be made. In that case start again, following the above procedures. The above procedures should also be followed to change the station preset for a given station button.

Note: If you have turned off the unit, and turn it on again, the unit will tune in to the station frequency to which it was tuned immediately before turn-off.

HUM AND NOISE

Hum often accompanies activation of power supply. If hum is generated, try replugging the power cord into the wall outlet, reversing the plug this time. Other possible causes of hum include improper routing of connecting cords (try changing cord position), or incorrect pin-plug insertion. Check all connections if hum persists.

If noise is introduced, it is usually caused by improper positioning of antenna cable or improper antenna installation. Use a 75-ohm cable for outdoor FM antenna and minimize multipath to obtain optimal signal reception. Note that during signal reception the unit may pick up noise from other household electric appliances (as when switching power on or off). In that case, check the relative location of the appliances and keep them away from the unit, or vice versa, as necessary.

SPECIFICATIONS

FM TUNER SECTION

Usable Sensitivity (mono)5 dBf/ 0.95 μ V (75 ohms)

50 dB Quieting Sensitivity:

Mono8.8 dBf/1.5 μ V (75 ohms)

Stereo31.2 dBf/20 μ V (75 ohms)

Signal-to-Noise Ratio (at 65 dBf):

Mono80 dB

Stereo75 dB

Harmonic Distortion (at 65 dBf):

1 kHz0.07% (mono), 0.25% (stereo)

Frequency Response30 to 15,000 Hz, +1 dB, -1 dB

Capture Ratio1.0 dB

Alternate Channel Selectivity

(\pm 400 kHz)63 dB

Spurious Response Ratio95 dB

Image Response Ratio70 dB

IF Response Ratio95 dB

AM Suppression Ratio58 dB

Stereo Separation100 Hz/1 kHz/10 kHz,

43 dB/46 dB/38 dB

Subcarrier Product Ratio60 dB

SCA Rejection Ratio70 dB

Antenna Input75 ohms unbalanced

AM TUNER SECTION

MW

LW (RT-850L)

Sensitivity350 μ V/m

750 μ V/m

Selectivity Wid/Narrow27 dB/42 dB

25 dB/40 dB

Signal-to-Noise Ratio60 dB

60 dB

Image Response Ratio40 dB

40 dB

IF Response Ratio40 dB

40 dB

AntennaLoop antenna

MISCELLANEOUS

Power Requirement120V/60 Hz, 220V/50 Hz, 240V/50 Hz

or 120, 220, 240V/50-60 Hz

(depending on destinations)

Power Consumption10 watts

Dimensions (overall)430 (W) x 66 (H) x 320 (D) mm

16-15/16" x 2-19/32" x 12-19/32"

Weight (net)3.8 kg/8.36 lbs

• Specifications and design subject to possible modification without notice.

VOLTAGE SELECTION

Not available for U.K., Canada and Scandinavia

The unit is a variable voltage equipment that can run on 120V, 220V or 240V power supply. Your unit should already be preset at the proper voltage for use in your area. However, if you move to an area where the power supply voltage is different, consult your dealer.